

STAINLESS STEEL FACED TIMBER CABINETS





Stainless Steel Faced Timber Cabinets

The more economical alternative to buying a full blown Stainless Steel Kitchen. Combining MFC carcasses with Stainless Steel Doors, End Panels & Fillers

Technical Specification

Hinge Options Standard	110° zinc plated steel hinges- soft closing Snap-on function; make it easy to remove the door for cleaning
Door/Drawer Panels	Manufactured from brushed stainless steel, bonded onto Titanium coloured MFC.
Finish Upgrade	The stainless steel panels can be powder coated to any colour, please specify the RAL colour when ordering.
Drawer Mechanism	Integrated damper that catches the running drawers so that they close slowly, silently and softly. Fully-extending drawers; for easy overview and access to the contents. Smooth-running drawers with stop. Drawers are self-closing the last few centimetres. Powder Coated steel- Colour Silver
Pan Drawer Mechanism	Integrated damper that catches the running drawers so that they close slowly, silently and softly. Fully-extending drawers; for easy overview and access to the contents. Smooth-running drawers with stop. Drawers are self-closing the last few centimetres. Powder Coated steel- Colour Silver
Carcase	Sturdy frame construction, 18 mm thick MFC Titanium Coloured
Handles	All cabinets are supplied as standard with a brushed steel 'T' bar handle (code- H01) other styles & lengths are available upoun request.

Available assembled or in flat pack form



* Prices quoted were correct at the time of going to print, and are ex. VAT and delivery.

Stainless Steel Faced Timber Cabinets

Base Cupboard Unit- Hinged Single Door

Code (Assembled)	Code (Flat Pack)	Description	Width	Depth	Height
HRA-C015 L/R	HRF-C015 L/R	Base Cupboard Unit- Hinged Single Door	150	585	870
HRA-C030 L/R	HRF-C030 L/R	Base Cupboard Unit- Hinged Single Door	300	585	870
HRA-C040 L/R	HRF-C040 L/R	Base Cupboard Unit- Hinged Single Door	400	585	870
HRA-C045 L/R	HRF-C045 L/R	Base Cupboard Unit- Hinged Single Door	450	585	870
HRA-C050 L/R	HRF-C050 L/R	Base Cupboard Unit- Hinged Single Door	500	585	870
HRA-C060 L/R	HRF-C060 L/R	Base Cupboard Unit- Hinged Single Door	600	585	870



Base Cupboard Sink Unit- Hinged Single Door

Code (Assembled)	Code (Flat Pack)	Description	Width	Depth	Height
HRA-C030S L/R	HRF-C030S L/R	Base Cupboard Sink Unit- Hinged Single Door	300	585	870
HRA-C040S L/R	HRF-C040S L/R	Base Cupboard Sink Unit- Hinged Single Door	400	585	870
HRA-C045S L/R	HRF-C045S L/R	Base Cupboard Sink Unit- Hinged Single Door	450	585	870
HRA-C050S L/R	HRF-C050S L/R	Base Cupboard Sink Unit- Hinged Single Door	500	585	870
HRA-C060S L/R	HRF-C060S L/R	Base Cupboard Sink Unit- Hinged Single Door	600	585	870



Base Cupboard Unit- Hinged Double Doors

Code (Assembled)	Code (Flat Pack)	Description	Width	Depth	Height
HRA-C080	HRF-C080	Base Cupboard Unit- Hinged Double Doors	800	585	870
HRA-C090	HRF-C090	Base Cupboard Unit- Hinged Double Doors	900	585	870
HRA-C100	HRF-C100	Base Cupboard Unit- Hinged Double Doors	1000	585	870
HRA-C120	HRF-C120	Base Cupboard Unit- Hinged Double Doors	1200	585	870



Base Cupboard Sink Unit- Hinged Double Doors

Code (Assembled)	Code (Flat Pack)	Description	Width	Depth	Height
HRA-C080S	HRF-C080S	Base Cupboard Sink Unit- Hinged Double Doors	800	585	870
HRA-C090S	HRF-C090S	Base Cupboard Sink Unit- Hinged Double Doors	900	585	870
HRA-C100S	HRF-C100S	Base Cupboard Sink Unit- Hinged Double Doors	1000	585	870
HRA-C120S	HRF-C120S	Base Cupboard Sink Unit- Hinged Double Doors	1200	585	870



Base Cupboard Straight Corner Unit- Hinged Single Door

Code (Assembled)	Code (Flat Pack)	Description	Width	Depth	Height
HRA-C080C L/R	HRF-C080C L/R	Base Cupboard Straight Corner Unit- Hinged Single Door	800	585	870
HRA-C090C L/R	HRF-C090C L/R	Base Cupboard Straight Corner Unit- Hinged Single Door	900	585	870
HRA-C100C L/R	HRF-C100C L/R	Base Cupboard Straight Corner Unit- Hinged Single Door	1000	585	870
HRA-C120C L/R	HRF-C120C L/R	Base Cupboard Straight Corner Unit- Hinged Single Door	1200	585	870



Base Cupboard Straight Corner Sink Unit- Hinged Single Door

Code (Assembled)	Code (Flat Pack)	Description	Width	Depth	Height
HRA-C080SC L/R	HRF-C080SC L/R	Base Cupboard Straight Corner Sink Unit- Hinged Single Door	800	585	870
HRA-C090SC L/R	HRF-C090SC L/R	Base Cupboard Straight Corner Sink Unit- Hinged Single Door	900	585	870
HRA-C100SC L/R	HRF-C100SC L/R	Base Cupboard Straight Corner Sink Unit- Hinged Single Door	1000	585	870
HRA-C120SC L/R	HRF-C120SC L/R	Base Cupboard Straight Corner Sink Unit- Hinged Single Door	1200	585	870



Base Cupboard Straight Corner Unit- c/w Linear Wire Baskets- Automatic Pull Out Action

Code (Assembled)	Code (Flat Pack)	Description	Width	Depth	Height
HRA-C090C-P L/R	HRF-C090C-P L/R	Base Cupboard Straight Corner Unit- c/w Linear Wire Baskets- Automatic Pull Out Action	900	585	870
HRA-C100C-P L/R	HRF-C100C-P L/R	Base Cupboard Straight Corner Unit- c/w Linear Wire Baskets- Automatic Pull Out Action	1000	585	870
HRA-C120C-P L/R	HRF-C120C-P L/R	Base Cupboard Straight Corner Unit- c/w Linear Wire Baskets- Automatic Pull Out Action	1200	585	870



Rear hanging frame and base mounting track; silver epoxy coated tubular steel
 Door frame with pivot; silver epoxy coated tubular steel
 Back frame; silver epoxy coated tubular steel
 Door frame follower; fiber glass improved plastic
 Door panel hanging plates; silver coloured steel,
 2No. Storage baskets (rear); linear chrome plated wire steel, max. load carrying capacity 9.5 kg
 2No. Storage baskets (door); linear chrome plated wire steel, max. load carrying capacity 8 kg

Base Cupboard Unit L Shaped- Bi Folding Door

Code (Assembled)	Code (Flat Pack)	Description	Width	Depth	Height
HRA-C090/090 L/R	HRF-C090/090 L/R	Base Cupboard Unit L Shaped- Bi Folding Door	900/900	585	870



Base Unit Bin Housings

Code (Assembled)	Code (Flat Pack)	Description	Width	Depth	Height
HRA-CB30/ECS30	HRF-CB30/ECS30	Base Unit- Pull Out Door/Bin. 1x 40 Litre Capacity Bin	300	585	870
HRA-CB45/TM45	HRF-CB45/TM45	Base Unit- Tilt Mechanism Door/Bin. 1x 30 Litre Capacity Bin	450	585	870
HRA-CB45/EC45	HRF-CB45/EC45	Base Unit- Pull Out Door/Bin. 2x 35, 2x 8.5 Litre Capacity Bins	450	585	870
HRA-CB50/EC50	HRF-CB50/EC50	Base Unit- Pull Out Door/Bin. 2x 35 Litre Capacity Bins	500	585	870
HRA-CB60/EC60	HRF-CB60/EC60	Base Unit- Pull Out Door/Bin. 2x 35, 2x 8.5 Litre Capacity Bins	600	585	870
HRA-CB45/ECS45	HRF-CB45/ECS45	Base Unit- Pull Out Door/Bin. 2x 19 Litre Capacity Bins	450	585	870
HRA-CB50/ECS50	HRF-CB50/ECS50	Base Unit- Pull Out Door/Bin. 1x 30, 1x 19 Litre Capacity Bins	500	585	870
HRA-CB60/ECS60	HRF-CB60/ECS60	Base Unit- Pull Out Door/Bin. 2x 30 Litre Capacity Bins	600	585	870



Drawerline Base Unit- Hinged Single Door + Drawer

Code (Assembled)	Code (Flat Pack)	Description	Width	Depth	Height
HRA-D030 L/R	HRF-D030 L/R	Drawerline Base Unit- Hinged Single Door + Drawer	300	585	870
HRA-D040 L/R	HRF-D040 L/R	Drawerline Base Unit- Hinged Single Door + Drawer	400	585	870
HRA-D045 L/R	HRF-D045 L/R	Drawerline Base Unit- Hinged Single Door + Drawer	450	585	870
HRA-D050 L/R	HRF-D050 L/R	Drawerline Base Unit- Hinged Single Door + Drawer	500	585	870
HRA-D060 L/R	HRF-D060 L/R	Drawerline Base Unit- Hinged Single Door + Drawer	600	585	870

**Drawerline Base Sink Unit- Hinged Single Door + False Drawer**

Code (Assembled)	Code (Flat Pack)	Description	Width	Depth	Height
HRA-D030S L/R	HRF-D030S L/R	Drawerline Base Sink Unit- Hinged Single Door + False Drawer	300	870	870
HRA-D040S L/R	HRF-D040S L/R	Drawerline Base Sink Unit- Hinged Single Door + False Drawer	400	870	870
HRA-D045S L/R	HRF-D045S L/R	Drawerline Base Sink Unit- Hinged Single Door + False Drawer	450	870	870
HRA-D050S L/R	HRF-D050S L/R	Drawerline Base Sink Unit- Hinged Single Door + False Drawer	500	870	870
HRA-D060S L/R	HRF-D060S L/R	Drawerline Base Sink Unit- Hinged Single Door + False Drawer	600	870	870

**Drawerline Base Unit- Hinged Double Doors + Drawers**

Code (Assembled)	Code (Flat Pack)	Description	Width	Depth	Height
HRA-D080	HRF-D080	Drawerline Base Unit- Hinged Double Doors + Drawers	800	585	870
HRA-D090	HRF-D090	Drawerline Base Unit- Hinged Double Doors + Drawers	900	585	870
HRA-D100	HRF-D100	Drawerline Base Unit- Hinged Double Doors + Drawers	1000	585	870
HRA-D120	HRF-D120	Drawerline Base Unit- Hinged Double Doors + Drawers	1200	585	870

**Drawerline Base Sink Unit- Hinged Double Doors + False Drawers**

Code (Assembled)	Code (Flat Pack)	Description	Width	Depth	Height
HRA-D080S	HRF-D080S	Drawerline Base Sink Unit- Hinged Double Doors + False Drawers	800	585	870
HRA-D090S	HRF-D090S	Drawerline Base Sink Unit- Hinged Double Doors + False Drawers	900	585	870
HRA-D100S	HRF-D100S	Drawerline Base Sink Unit- Hinged Double Doors + False Drawers	1000	585	870
HRA-D120S	HRF-D120S	Drawerline Base Sink Unit- Hinged Double Doors + False Drawers	1200	585	870

**Drawerline Base St. Corner Unit- Hinged Single Door + Drawer**

Code (Assembled)	Code (Flat Pack)	Description	Width	Depth	Height
HRA-D080C L/R	HRF-D080C L/R	Drawerline Base St. Corner Unit- Hinged Single Door + Drawer	800	585	870
HRA-D090C L/R	HRF-D090C L/R	Drawerline Base St. Corner Unit- Hinged Single Door + Drawer	900	585	870
HRA-D100C L/R	HRF-D100C L/R	Drawerline Base St. Corner Unit- Hinged Single Door + Drawer	1000	585	870
HRA-D120C L/R	HRF-D120C L/R	Drawerline Base St. Corner Unit- Hinged Single Door + Drawer	1200	585	870

**Drawerline Base St. Corner Sink Unit- Hinged Single Door + Drawer**

Code (Assembled)	Code (Flat Pack)	Description	Width	Depth	Height
HRA-D080SC L/R	HRF-D080SC L/R	Drawerline Base St. Corner Sink Unit- Hinged Single Door + Drawer	800	585	870
HRA-D090SC L/R	HRF-D090SC L/R	Drawerline Base St. Corner Sink Unit- Hinged Single Door + Drawer	900	585	870
HRA-D100SC L/R	HRF-D100SC L/R	Drawerline Base St. Corner Sink Unit- Hinged Single Door + Drawer	1000	585	870
HRA-D120SC L/R	HRF-D120SC L/R	Drawerline Base St. Corner Sink Unit- Hinged Single Door + Drawer	1200	585	870

**Base Drawer Pack- 2No. Drawers**

Code (Assembled)	Code (Flat Pack)	Description	Width	Depth	Height
HRA-DD030-2	HRF-DD030-2	Base Drawer Pack- 2No. Drawers	400	585	870
HRA-DD040-2	HRF-DD040-2	Base Drawer Pack- 2No. Drawers	400	585	870
HRA-DD045-2	HRF-DD045-2	Base Drawer Pack- 2No. Drawers	450	585	870
HRA-DD050-2	HRF-DD050-2	Base Drawer Pack- 2No. Drawers	500	585	870
HRA-DD060-2	HRF-DD060-2	Base Drawer Pack- 2No. Drawers	600	585	870
HRA-DD080-2	HRF-DD080-2	Base Drawer Pack- 2No. Drawers	800	585	870
HRA-DD090-2	HRF-DD090-2	Base Drawer Pack- 2No. Drawers	900	585	870
HRA-DD100-2	HRF-DD100-2	Base Drawer Pack- 2No. Drawers	1000	585	870
HRA-DD120-2	HRF-DD120-2	Base Drawer Pack- 2No. Drawers	1200	585	870

**Base Drawer Pack- 3No. Drawers**

Code (Assembled)	Code (Flat Pack)	Description	Width	Depth	Height
HRA-DD030-3	HRF-DD030-3	Base Drawer Pack- 3No. Drawers	300	585	870
HRA-DD040-3	HRF-DD040-3	Base Drawer Pack- 3No. Drawers	400	585	870
HRA-DD045-3	HRF-DD045-3	Base Drawer Pack- 3No. Drawers	450	585	870
HRA-DD050-3	HRF-DD050-3	Base Drawer Pack- 3No. Drawers	500	585	870
HRA-DD060-3	HRF-DD060-3	Base Drawer Pack- 3No. Drawers	600	585	870
HRA-DD080-3	HRF-DD080-3	Base Drawer Pack- 3No. Drawers	800	585	870
HRA-DD090-3	HRF-DD090-3	Base Drawer Pack- 3No. Drawers	900	585	870
HRA-DD100-3	HRF-DD100-3	Base Drawer Pack- 3No. Drawers	1000	585	870
HRA-DD120-3	HRF-DD120-3	Base Drawer Pack- 3No. Drawers	1200	585	870

**Base Drawer Pack- 4No. Drawers**

Code (Assembled)	Code (Flat Pack)	Description	Width	Depth	Height
HRA-DD030-4	HRF-DD030-4	Base Drawer Pack- 4No. Drawers	300	585	870
HRA-DD040-4	HRF-DD040-4	Base Drawer Pack- 4No. Drawers	400	585	870
HRA-DD045-4	HRF-DD045-4	Base Drawer Pack- 4No. Drawers	450	585	870
HRA-DD050-4	HRF-DD050-4	Base Drawer Pack- 4No. Drawers	500	585	870
HRA-DD060-4	HRF-DD060-4	Base Drawer Pack- 4No. Drawers	600	585	870
HRA-DD080-4	HRF-DD080-4	Base Drawer Pack- 4No. Drawers	800	585	870
HRA-DD090-4	HRF-DD090-4	Base Drawer Pack- 4No. Drawers	900	585	870
HRA-DD100-4	HRF-DD100-4	Base Drawer Pack- 4No. Drawers	1000	585	870
HRA-DD120-4	HRF-DD120-4	Base Drawer Pack- 4No. Drawers	1200	585	870

**Base Unit Oven Housing**

Code (Assembled)	Code (Flat Pack)	Description	Width	Depth	Height
HRA-D060H	HRF-DH060	Base Unit Oven Housing	600	585	870
HRA-D060H-D	HRF-DH060-D	Base Unit Oven Housing- 1No. Drawer under	600	585	870



Wall Cupboard- Hinged Single Door, 1# Internal Shelf - Height 575

	Code Assembled	Code (Flat Pack)	Description	Width	Depth	Height
	HRA-W030-575L/R	HRF-W030-575L/R	Wall Cupboard- Hinged Single Door, 1# Internal Shelf	300	325	575
	HRA-W040-575L/R	HRF-W030-575L/R	Wall Cupboard- Hinged Single Door, 1# Internal Shelf	400	325	575
	HRA-W045-575L/R	HRF-W030-575L/R	Wall Cupboard- Hinged Single Door, 1# Internal Shelf	450	325	575
	HRA-W050-575L/R	HRF-W030-575L/R	Wall Cupboard- Hinged Single Door, 1# Internal Shelf	500	325	575
	HRA-W060-575L/R	HRF-W030-575L/R	Wall Cupboard- Hinged Single Door, 1# Internal Shelf	600	325	575

Wall Cupboard- Hinged Single Door, 2# Internal Shelf - Height 720

	Code (Assembled)	Code (Flat Pack)	Description	Width	Depth	Height
	HRA-W030-720L/R	HRF-W030-720L/R	Wall Cupboard- Hinged Single Door, 2# Internal Shelf	300	325	720
	HRA-W040-720L/R	HRF-W040-720L/R	Wall Cupboard- Hinged Single Door, 2# Internal Shelf	400	325	720
	HRA-W045-720L/R	HRF-W045-720L/R	Wall Cupboard- Hinged Single Door, 2# Internal Shelf	450	325	720
	HRA-W050-720L/R	HRF-W050-720L/R	Wall Cupboard- Hinged Single Door, 2# Internal Shelf	500	325	720
	HRA-W060-720L/R	HRF-W060-720L/R	Wall Cupboard- Hinged Single Door, 2# Internal Shelf	600	325	720

Wall Cupboard- Hinged Single Door, 2# Internal Shelf - Height 900

	Code (Assembled)	Code (Flat Pack)	Description	Width	Depth	Height
	HRA-W030-900L/R	HRF-W030-900L/R	Wall Cupboard- Hinged Single Door, 2# Internal Shelf	300	325	900
	HRA-W040-900L/R	HRF-W040-900L/R	Wall Cupboard- Hinged Single Door, 2# Internal Shelf	400	325	900
	HRA-W045-900L/R	HRF-W045-900L/R	Wall Cupboard- Hinged Single Door, 2# Internal Shelf	450	325	900
	HRA-W050-900L/R	HRF-W050-900L/R	Wall Cupboard- Hinged Single Door, 2# Internal Shelf	500	325	900
	HRA-W060-900L/R	HRF-W060-900L/R	Wall Cupboard- Hinged Single Door, 2# Internal Shelf	600	325	900

Wall Cupboard- Hinged Double Door, 1# Internal Shelf - Height 575

	Code (Assembled)	Code (Flat Pack)	Description	Width	Depth	Height
	HRA-W080-575	HRF-W080-575	Wall Cupboard- Hinged Double Door, 1# Internal Shelf	800	325	575
	HRA-W090-575	HRF-W090-575	Wall Cupboard- Hinged Double Door, 1# Internal Shelf	900	325	575
	HRA-W100-575	HRF-W100-575	Wall Cupboard- Hinged Double Door, 1# Internal Shelf	1000	325	575
	HRA-W120-575	HRF-W120-575	Wall Cupboard- Hinged Double Door, 1# Internal Shelf	1200	325	575

Wall Cupboard- Hinged Double Door, 2# Internal Shelf - Height 720

	Code (Assembled)	Code (Flat Pack)	Description	Width	Depth	Height
	HRA-W080-720	HRF-W080-720	Wall Cupboard- Hinged Double Door, 2# Internal Shelf	800	325	720
	HRA-W090-720	HRF-W090-720	Wall Cupboard- Hinged Double Door, 2# Internal Shelf	900	325	720
	HRA-W100-720	HRF-W100-720	Wall Cupboard- Hinged Double Door, 2# Internal Shelf	1000	325	720
	HRA-W120-720	HRF-W120-720	Wall Cupboard- Hinged Double Door, 2# Internal Shelf	1200	325	720

Wall Cupboard- Hinged Double Door, 2# Internal Shelf - Height 900

	Code (Assembled)	Code (Flat Pack)	Description	Width	Depth	Height
	HRA-W080-900	HRF-W080-900	Wall Cupboard- Hinged Double Door, 2# Internal Shelf	800	325	900
	HRA-W090-900	HRF-W090-900	Wall Cupboard- Hinged Double Door, 2# Internal Shelf	900	325	900
	HRA-W100-900	HRF-W100-900	Wall Cupboard- Hinged Double Door, 2# Internal Shelf	1000	325	900
	HRA-W120-900	HRF-W120-900	Wall Cupboard- Hinged Double Door, 2# Internal Shelf	1200	325	900

Wall Cupboard Straight Corner Unit- Hinged Single Door, 1# Internal Shelf - Height 575

	Code (Assembled)	Code (Flat Pack)	Description	Width	Depth	Height
	HRA-W080-575C L/R	HRF-W080-575C L/R	Wall Cupboard Straight Corner Unit- Hinged Single Door, 1# Internal Shelf	800	325	575
	HRA-W090-575C L/R	HRF-W090-575C L/R	Wall Cupboard Straight Corner Unit- Hinged Single Door, 1# Internal Shelf	900	325	575
	HRA-W100-575C L/R	HRF-W100-575C L/R	Wall Cupboard Straight Corner Unit- Hinged Single Door, 1# Internal Shelf	1000	325	575
	HRA-W120-575C L/R	HRF-W120-575C L/R	Wall Cupboard Straight Corner Unit- Hinged Single Door, 1# Internal Shelf	1200	325	575

Wall Cupboard Straight Corner Unit- Hinged Single Door, 2# Internal Shelves - Height 720

	Code (Assembled)	Code (Flat Pack)	Description	Width	Depth	Height
	HRA-W080-720C L/R	HRF-W080-720C L/R	Wall Cupboard Straight Corner Unit- Hinged Single Door, 2# Internal Shelves	800	325	720
	HRA-W090-720C L/R	HRF-W090-720C L/R	Wall Cupboard Straight Corner Unit- Hinged Single Door, 2# Internal Shelves	900	325	720
	HRA-W100-720C L/R	HRF-W100-720C L/R	Wall Cupboard Straight Corner Unit- Hinged Single Door, 2# Internal Shelves	1000	325	720
	HRA-W120-720C L/R	HRF-W120-720C L/R	Wall Cupboard Straight Corner Unit- Hinged Single Door, 2# Internal Shelves	1200	325	720

Wall Cupboard Straight Corner Unit- Hinged Single Door, 2# Internal Shelves - Height 900

	Code (Assembled)	Code (Flat Pack)	Description	Width	Depth	Height
	HRA-W080-900C L/R	HRF-W080-900C L/R	Wall Cupboard Straight Corner Unit- Hinged Single Door, 2# Internal Shelves	800	325	900
	HRA-W090-900C L/R	HRF-W090-900C L/R	Wall Cupboard Straight Corner Unit- Hinged Single Door, 2# Internal Shelves	900	325	900
	HRA-W100-900C L/R	HRF-W100-900C L/R	Wall Cupboard Straight Corner Unit- Hinged Single Door, 2# Internal Shelves	1000	325	900
	HRA-W120-900C L/R	HRF-W120-900C L/R	Wall Cupboard Straight Corner Unit- Hinged Single Door, 2# Internal Shelves	1200	325	900

Wall L Shaped Cupboard- Bi-Folding Door, 1 - 2# Internal Shelf - Height 570/720/900

	Code (Assembled)	Code (Flat Pack)	Description	Width	Depth	Height
	HRA-WC090-575C L/R	HRF-WC090-575C L/R	Wall L Shaped Cupboard- Bi-Folding Door, 1# Internal Shelf	600/600	325	575
	HRA-WC090-720C L/R	HRF-WC090-720C L/R	Wall L Shaped Cupboard- Bi-Folding Door, 2# Internal Shelves	600/600	325	720
	HRA-WC090-900C L/R	HRF-WC090-900C L/R	Wall L Shaped Cupboard- Bi-Folding Door, 2# Internal Shelves	600/600	325	900

Tall Appliance Housings- Height 2120

Item	Code (Assembled)	Code (Flat Pack)	Description	Width	Depth	Height
A	HRA-TH65DO-C L/R	HRF-TH65DO-C L/R	Tall Appliance Housing- Double Oven, 2# Hinged Doors	600	585	2120
B	HRA-TH65DO-DD L/R	HRF-TH65DO-DD L/R	Tall Appliance Housing- Double Oven, 2# Pan Drawers + 1# Hinged Door	600	585	2120
C	HRA-TH65SO-DD L/R	HRF-TH65SO-DD L/R	Tall Appliance Housing- Single Oven, 1# Drawer + 1# Pan Drawer + 1# Hinged Door	600	585	2120
D	HRA-TH65M-DD L/R	HRF-TH65M-DD L/R	Tall Appliance Housing- Microwave, 2# Pan Drawers + 1# Hinged Door	600	585	2120



A



B



C



D

Top Box for Appliance/Larder Units

Code (Assembled)	Code (Flat Pack)	Description	Width	Depth	Height
HRA-TB64	HRF-TB64	Top Box	600	300	360



Tall Larder- hinged doors - Height 2120

Code (Assembled)	Code (Flat Pack)	Description	Width	Depth	Height
HRA-L030-2120 L/R	HRF-L030-2120 L/R	Tall Larder- hinged doors	300	585	2120
HRA-L040-2120 L/R	HRF-L040-2120 L/R	Tall Larder- hinged doors	400	585	2120
HRA-L050-2120 L/R	HRF-L050-2120 L/R	Tall Larder- hinged doors	500	585	2120
HRA-L060-2120 L/R	HRF-L060-2120 L/R	Tall Larder- hinged doors	600	585	2120



- 5x Adjustable height internal shelves. • Hinged Single Door

Tall Larder- pull out unit/door - Height 2120

Code (Assembled)	Code (Flat Pack)	Description	Width	Depth	Height
HRA-L030-2120P	HRF-L030-2120P	Tall Larder- pull out unit/door	300	585	2120
HRA-L040-2120P	HRF-L040-2120P	Tall Larder- pull out unit/door	400	585	2120
HRA-L050-2120P	HRF-L050-2120P	Tall Larder- pull out unit/door	500	585	2120
HRA-L060-2120P	HRF-L060-2120P	Tall Larder- pull out unit/door	600	585	2120



- 5x baskets included
- Built-in depth 470 mm
- Set includes:
 - Hanging frame, silver epoxy coated tubular steel, height adjustable
 - Top and bottom runners, zinc painted steel, full extension, ball cage top runner and self closing bottom roller runner, max. load carrying capacity 80 kg per unit
 - Storage baskets, chrome plated steel, four basket widths to suit cabinet widths, linear chrome wire style.
 - Basket hanging clips, grey plastic

Accessories

	Code Assembled	Description	Width	Depth	Height
End Panels	EB10-090-650	Base Unit- End Panel (oversized to cut down to suit)	20	650	900
	EB10-2150-650	Tall Unit- End Panel (oversized to cut down to suit)	20	650	2150
	EB10-2500-650	Tall Unit- End Panel (oversized to cut down to suit)	20	650	2500
	EW575	Wall Unit- End Panel H575	20	325	575
	EW720	Wall Unit- End Panel H720	20	325	720
	EW900	Wall Unit- End Panel H900	20	325	900
Filler Panels	F575-15	Wall Cupboard Filler Panel H575	150	20	575
	F720-15	Base/Wall Cupboard Filler Panel H720	150	20	720
	F900-15	Wall Cupboard Filler Panel H900	150	20	900
	F1970-15	Tall Unit Filler Panel for 2120mm high unit (1970 without legs)	150	20	1970
	F2330-15	Tall Unit Filler Panel for H2120 (1970 without legs) + Top Box H360mm	150	20	2330
	Plinths	P10-015	Plinth- Brushed Stainless Steel Finish	150	20
P10-030		Plinth- Brushed Stainless Steel Finish	300	20	145
P10-040		Plinth- Brushed Stainless Steel Finish	400	20	145
P10-045		Plinth- Brushed Stainless Steel Finish	450	20	145
P10-050		Plinth- Brushed Stainless Steel Finish	500	20	145
P10-060		Plinth- Brushed Stainless Steel Finish	600	20	145
P10-080		Plinth- Brushed Stainless Steel Finish	800	20	145
P10-090		Plinth- Brushed Stainless Steel Finish	900	20	145
P10-100		Plinth- Brushed Stainless Steel Finish	1000	20	145
P10-1200		Plinth- Brushed Stainless Steel Finish	1200	20	145
Pelmet	PP10	Pelmet (please enquire)	Various	20	50

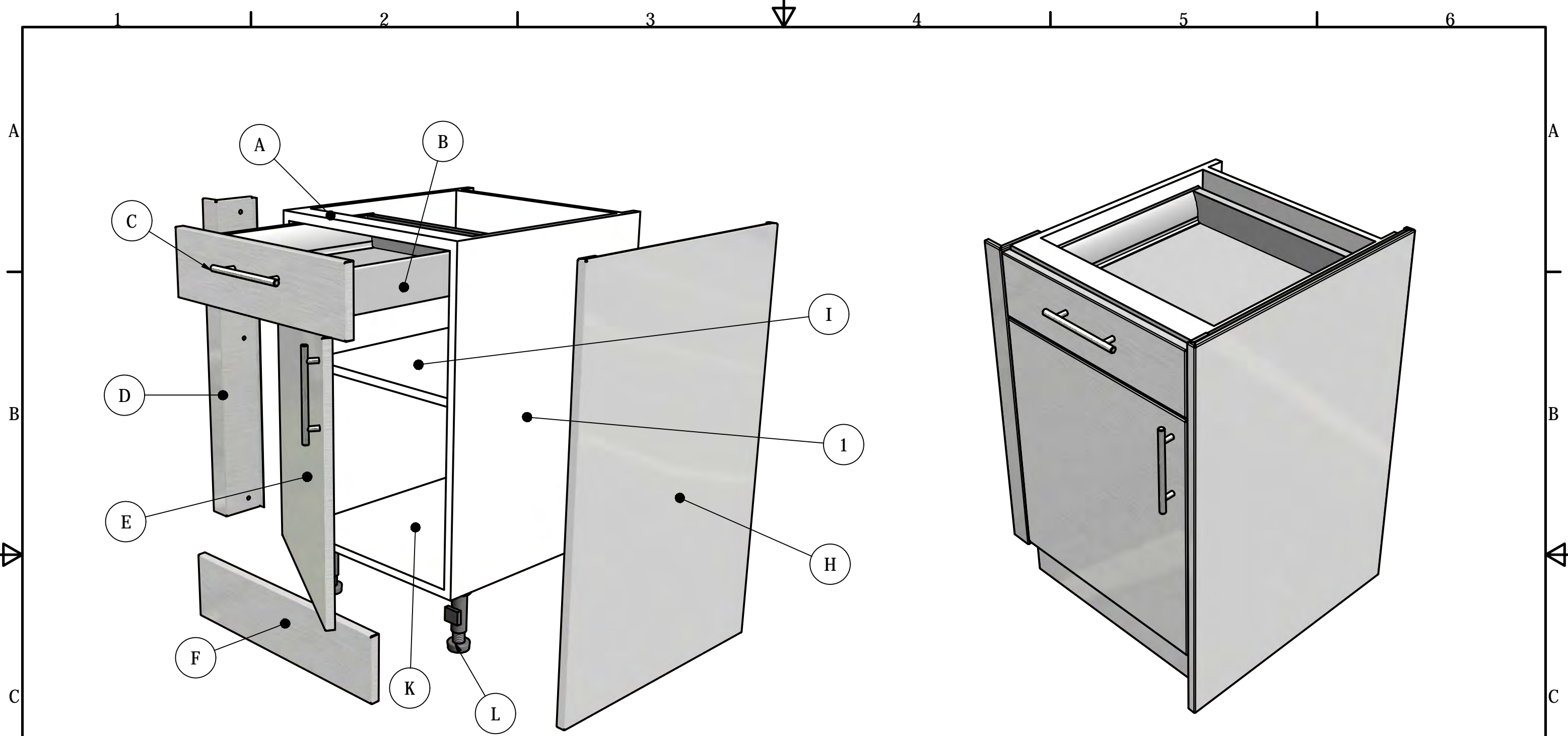

- A) Supports for securing worktop- MFC construction
- B) Drawer assembly with self closing runners. Drawer front(s) stainless steel, can be coloured*
- C) Bar type pull handles- see our handle range for alternatives
- D) Filler panels- Stainless Steel (req'd if unit is the last cabinet in a run finishing against a wall or if it is the last cabinet in a run adjoining adjacent units to form an 'L' shaped or 'U' shaped run) can be coloured*
- E) Hinged door (available left or right handed) Door front Stainless Steel- can be coloured*
- F) Removable plinth panel. Stainless Steel- can be coloured*
- H) Decorative end panel- Stainless Steel (req'd if unit stands on its own or is last unit at the end of a run) can be coloured*
- I) Internal adjustable height shelf- MFC
- J) Exposed sides of unit unfinished- MFC (when visible filler / end panels will be required)
- K) Internal fixed base shelf- MFC
- L) Height adjustable legs- Plastic

* see our RAL colour sheet for available colours

Designed by JV	Checked by	Approved by	Date	Scale:-	Date 06/12/2010
CLIENT: Cavendish Equipment Ltd. PROJECT: St/St Faced Timber Cabinets DESC: St/Steel + MFC			CAVENDISH EQUIPMENT LIMITED		
			Explosed Views		Sheet 1 / 2

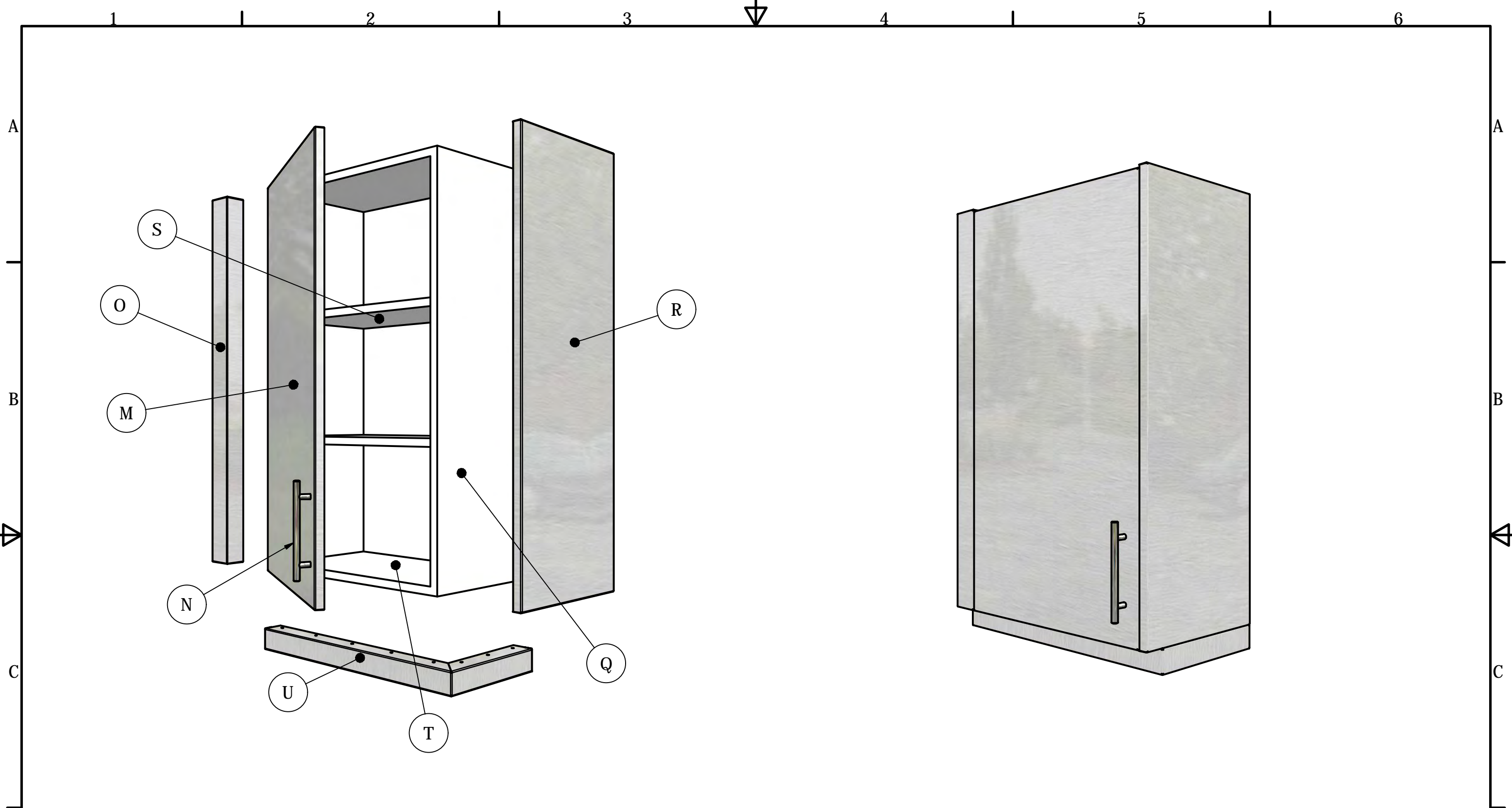

- M) Hinged Door (available left or right handed) Door front Stainless Steel- can be coloured*
- N) Bar type pull handle- see our handle range for alternatives
- O) Filler panel- Stainless Steel (req'd if unit is the last cabinet in a run finishing against a wall) this can be coloured*
- P) Cabinet hung on wall with adjustable fixing brackets (not shown)
- Q) Exposed sides of unit unfinished- MFC (when visible, filler/end panels will be required)
- R) Decorative end panel- Stainless Steel (req'd if unit is hung on its own or is last unit at the end of a run) this can be coloured*
- S) Internal centre adjustable shelf- MFC
- T) Internal fixed base shelf- MFC
- U) Valance panel- Stainless Steel (req'd if units are having lighting fitted underneath) this can be coloured*

* see our RAL colour sheet for available colours

Designed by JV	Checked by	Approved by	Date	Scale:-	Date 06/12/2010
CLIENT: Cavendish Equipment Ltd. PROJECT: St/St Faced Timber Cabinets DESC: St/Steel + MFC			CAVENDISH EQUIPMENT LIMITED		
			Explosed Views		Sheet 2 / 2

Name	MR J SMITH		
Company Name	If applicable		
Address	THE PLACE, No.1 The Lane, Sometown, Somewhere		
Postcode	254 548	Email	MAIL@MAIL.COM
Telephone No	118 118	Mobile	Fax
Project Ref	NEW ST/STEEL KITCHEN		

Services Required	Template, Supply & Install	<input checked="" type="radio"/>
	Template, Supply & Delivery Only	<input type="radio"/>
	Supply & Collection Only	<input type="radio"/>
	Supply & Delivery Only	<input type="radio"/>
Delivery / Installation Address (if different)		

CAVENDISH EQUIPMENT LIMITED
 Tel No. 01992 767105
 Fax No. 01992 716927
 sales@cavendishequipment.co.uk
 Specialists in the manufacture and installation of stainless steel kitchens, including worktops, cabinets & splashbacks

Cabinet Specification			
Item	Description	Qty	Model
1	END PANEL	1	EB10
2	APPLIANCE HOUSING	1	TH65DOC
3	WALL CUPB'D-SGL DOOR	1	W66L
4	WALL CUPB'D-DBL DOOR	1	W126
5	FILLER PANEL	1	F600
6	PELMET- L1860MM	1	N/A
7	TAP- BY OTHERS	1	TBA
8	WORKTOP- SEE ATTACHED	1	N/A
9	FILLER PANEL	1	F732
10	BASE CUPB'D+DRAWER	1	D65SL
11	DRAWER PACK-3	1	DD65-3
12	END PANEL	1	EB10
13	PLINTH- L2480MM	1	N/A
14			
15			
16			
17			
18			
19			
20			
21			
22			
23			
24			
25			
26			
27			
28			
29			
30			

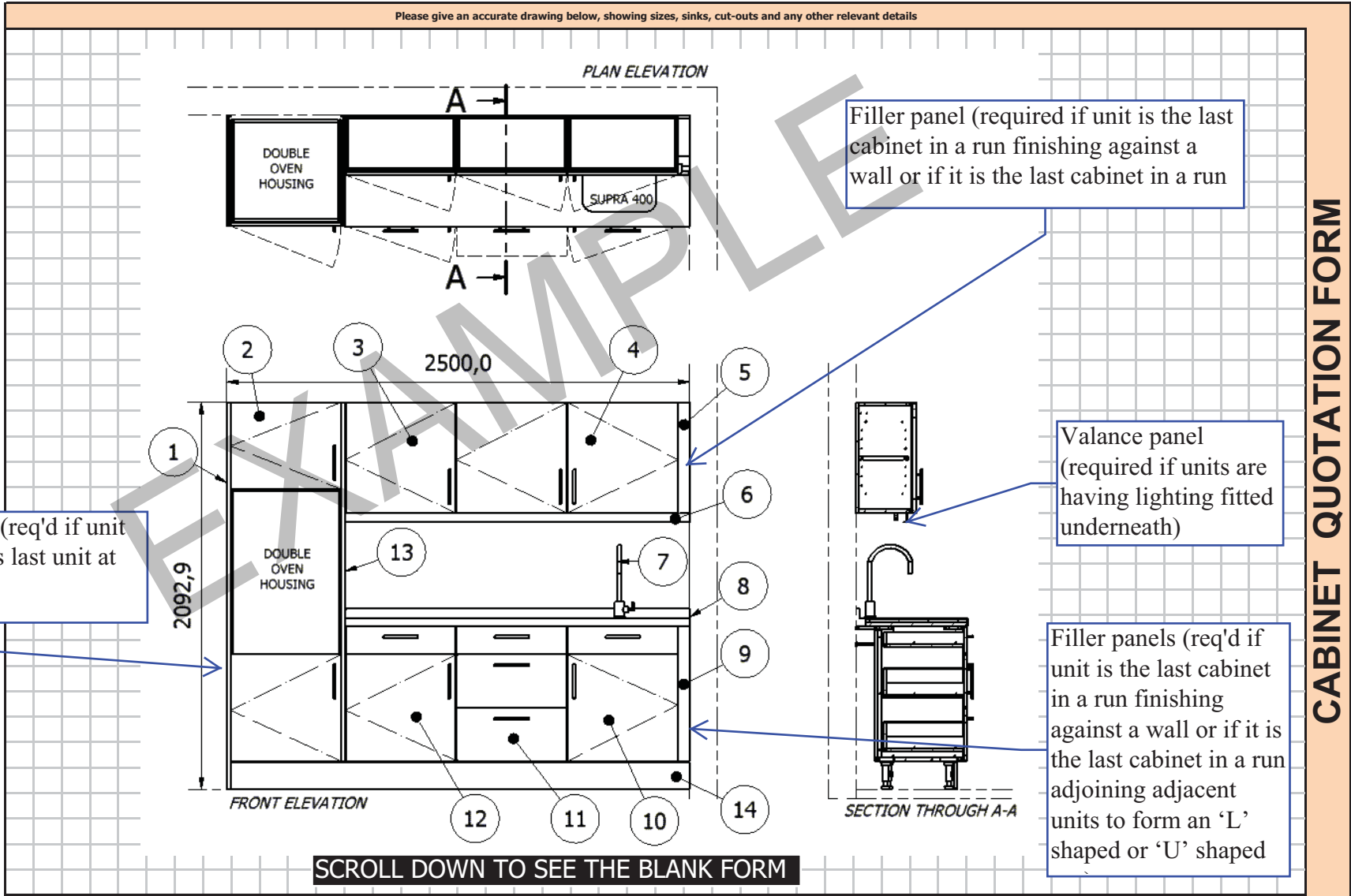

SCROLL DOWN TO SEE THE BLANK FORM

CABINET QUOTATION FORM

Additional Information
 GROUND FLOOR, GOOD ACCESS + PARKING

Name			
Company Name	<i>If applicable</i>		
Address			
Postcode		Email	
Telephone No		Mobile	Fax
Project Ref			

Services Required	Template, Supply & Install
	Template, Supply & Delivery Only
	Supply & Collection Only
	Supply & Delivery Only
Delivery / Installation Address (if different)	

CAVENDISH EQUIPMENT LIMITED
 Tel No. 01992 767105
 Fax No. 01992 716927
 sales@cavendishequipment.co.uk
 Specialists in the manufacture and installation of stainless steel kitchens, including worktops, cabinets & splashbacks

Cabinet Specification ?			
Item	Description	Qty	Model
1			
2			
3			
4			
5			
6			
7			
8			
9			
10			
11			
12			
13			
14			
15			
16			
17			
18			
19			
20			
21			
22			
23			
24			
25			
26			
27			
28			
29			
30			
Additional Information			

Please give an accurate drawing below, showing sizes, sinks, cut-outs and any other relevant details

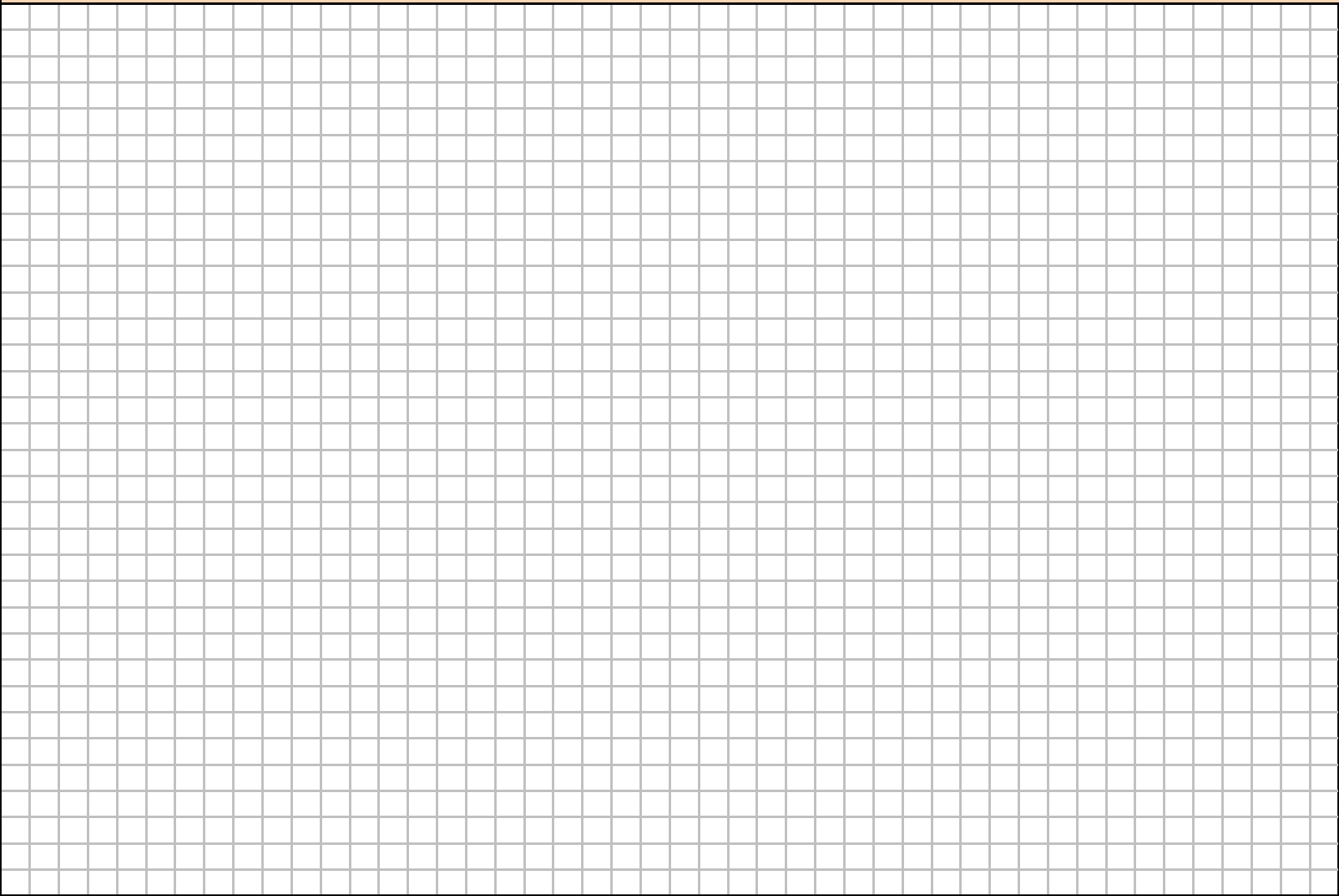

CABINET QUOTATION FORM

Cavendish Equipment established in 1967, are market leaders in the manufacture and installation of high quality stainless steel kitchens.

We manufacture a wide range of stainless steel products including worktops, splashbacks and cabinets to suit both the domestic and commercial environments. We are also able to offer a bespoke service to suit your individual needs. Please view our products section to see what is available.

E & OE. Due to a policy of continual product improvement, Cavendish Equipment Ltd. reserves the right to alter specifications and prices without prior notice.

The information and the designs of the products shown here within are the property of Cavendish Equipment Ltd. must not be copied, reproduced or electronically stored in any way without the prior consent of the proprietors Cavendish Equipment Limited. ©

Cavendish Equipment Ltd.
Monro Industrial Estate,
Station Approach,
Waltham Cross,
Hertfordshire,
EN8 7LX

Sales

Tel No. 01992 715 454
Fax No. 01992 716 927
sales @ cavendishequipment.co.uk
www.cavendishequipment.co.uk

Co. Registration 919294



DESIGNED & PRODUCED BY JV